

All Stacked Up

Dessiné, réalisé et quilté par **Barbara Cherniwchan**
pour **Coach House Designs**

INSTRUCTIONS D'IMPRESSION

PRINTING INSTRUCTIONS

Cliquez sur **FICHIER > IMPRIMER**
ou sur l'icône pour accéder aux paramètres d'impression de vos gabarits.

Sélectionnez ensuite **le format papier A4**.

Dans les options de mise à l'échelle, **saisissez 100 %** ou sélectionner **l'option taille réelle**.

N'adaptez jamais à la taille car cela déformera l'échelle de vos gabarits.

Lorsque vous êtes prêt, cliquez sur Imprimer.

*Click on **File > Print***

or on an icon to get to the print parameters of your templates.

*Then choose **A4 paper size**.*

*In the scaling options, **enter 100%** or choose **the actual-size option**.*

Do not adjust to fit the size as that will distort the scale of your templates.

When ready, click Print.

ATTENTION

IMPORTANT NOTE

Pour les **ÉTATS-UNIS**, assurez-vous de sélectionner **le format US Letter**,
puis dans les options de mise à l'échelle, **saisissez 100 %** ou sélectionner **l'option taille réelle**.

N'adaptez jamais à la taille car cela déformera l'échelle de vos gabarits.

Lorsque vous êtes prêt, cliquez sur Imprimer.

*For those in the **United States**, make sure that you choose **U.S. Letter size**,
then in the scaling options for printing, **enter 100%** or select **the actual-size option**.*

Do not adjust to fit the size as that will distort the scale of your templates.

When ready, click Print.

Pour vous assurer que votre gabarit
a été imprimé correctement, mesurez
ce carré sur les pages à l'aide d'une règle.
Si la mesure est correcte, votre gabarit
est imprimé à la perfection et vous êtes prêt
à commencer votre travail.

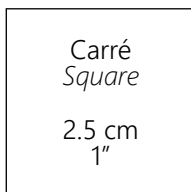

*To make sure that your template was correctly
printed, use a ruler to measure this square
on the pages. If the measurement is correct,
your template was accurately printed
and you are ready to begin working.*

a ▶

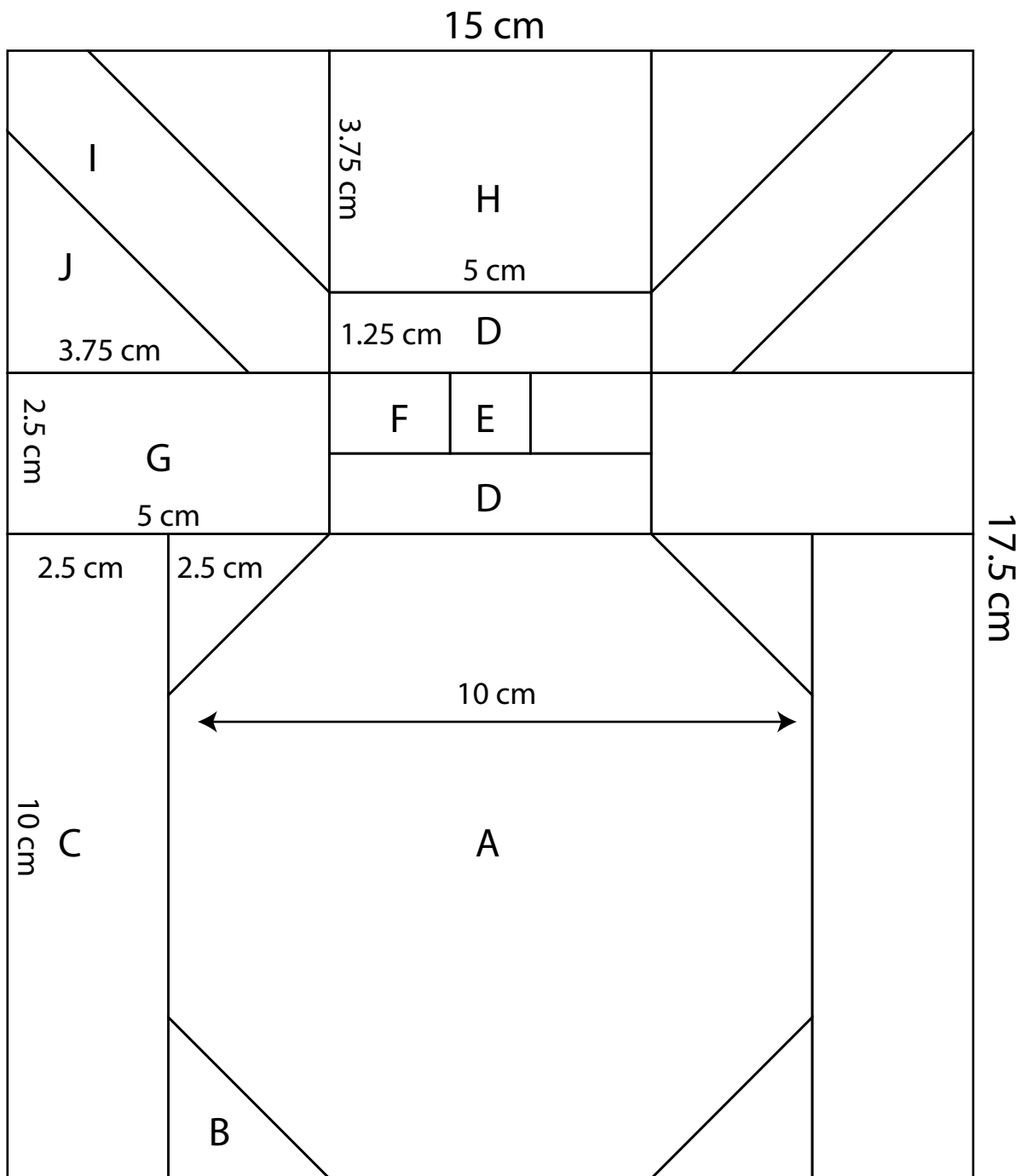

Unité / Unit 1 x 6

Section 1

► a

b ►

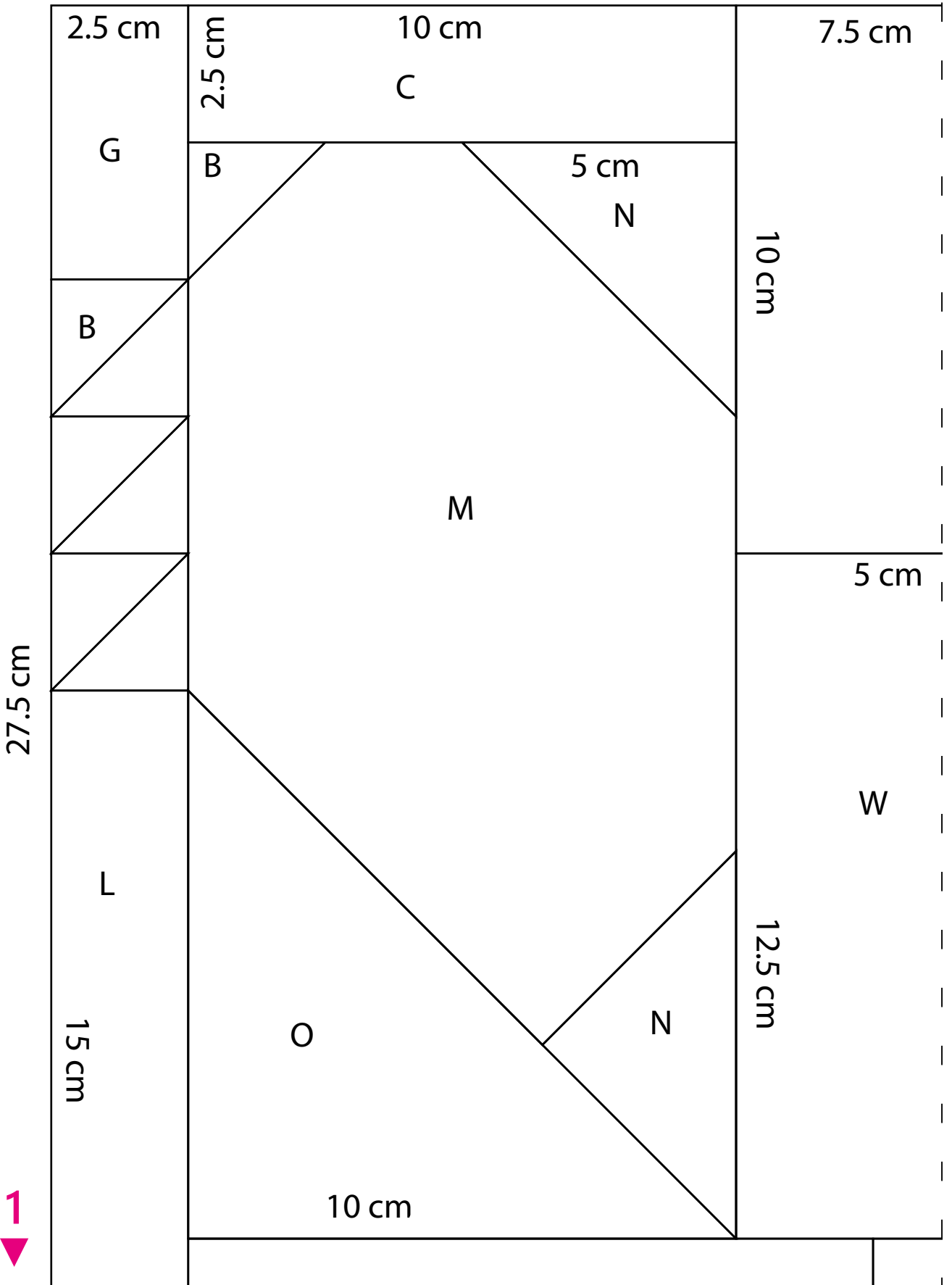

1 ▼

▼
1

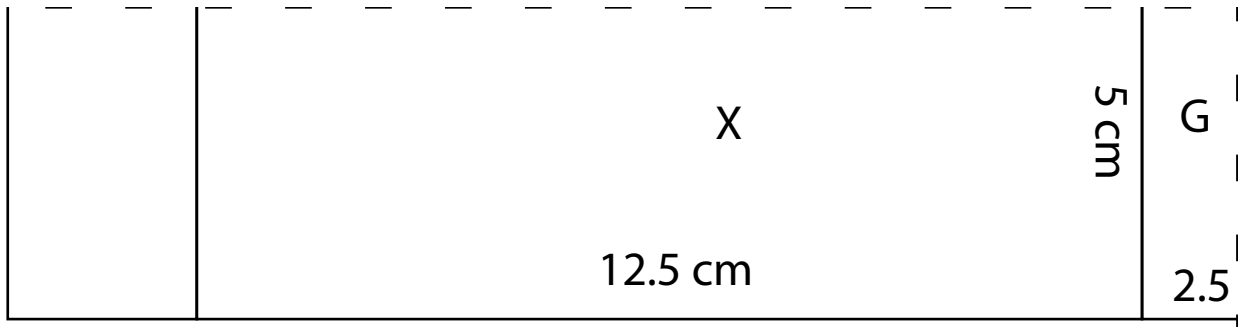

Section 2

m ►

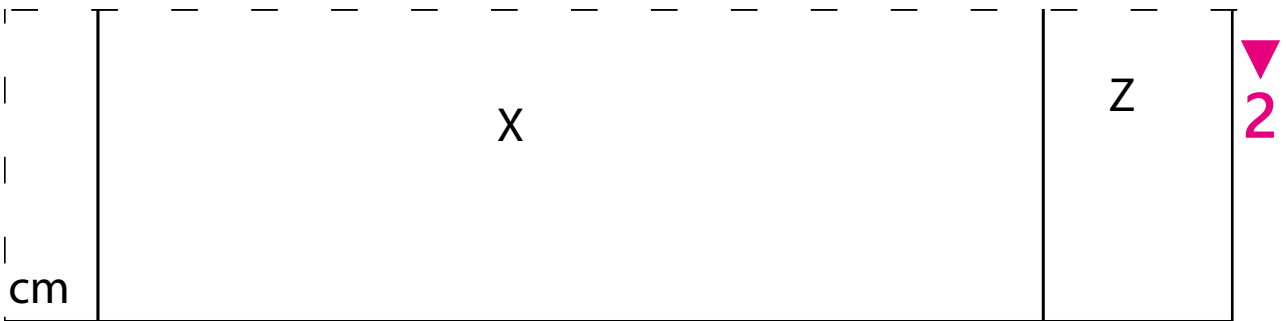

► m

n ►

▼
3

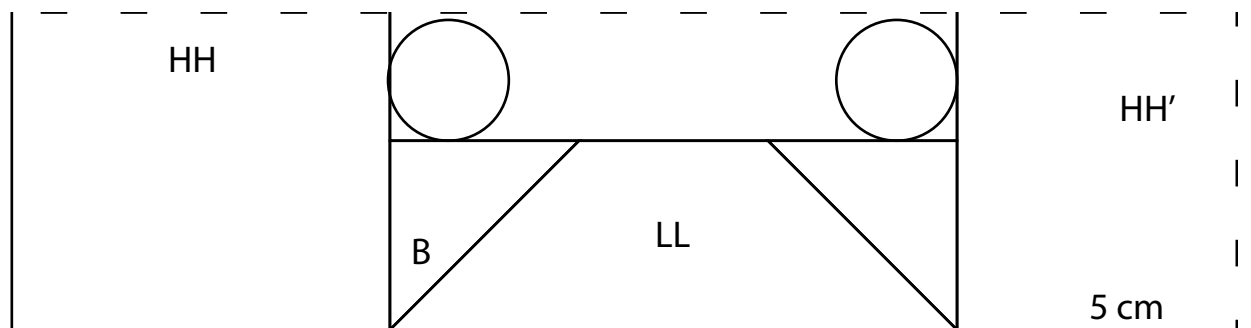

► n

Section 3

o ►

► b

c ►

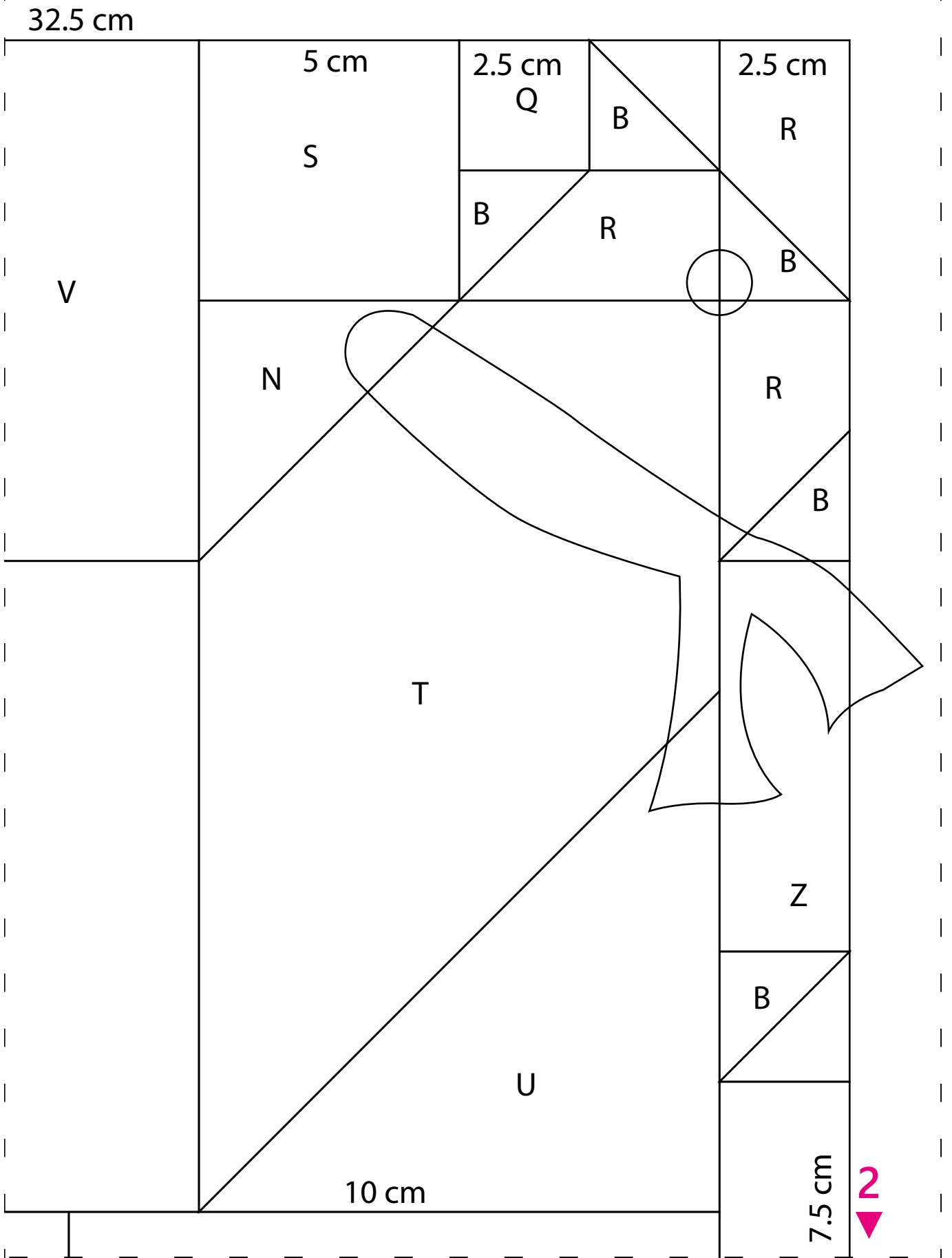

c

d

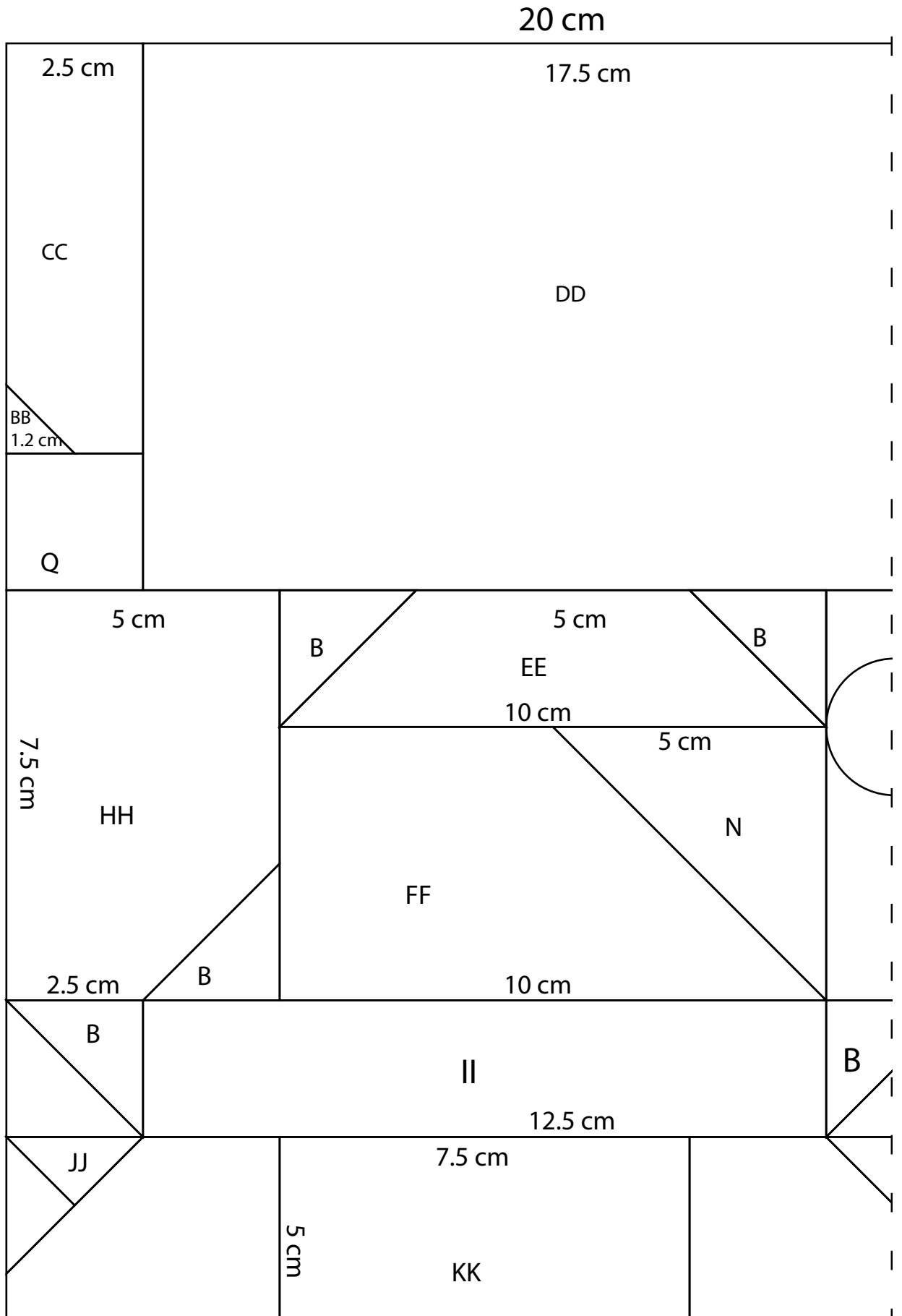

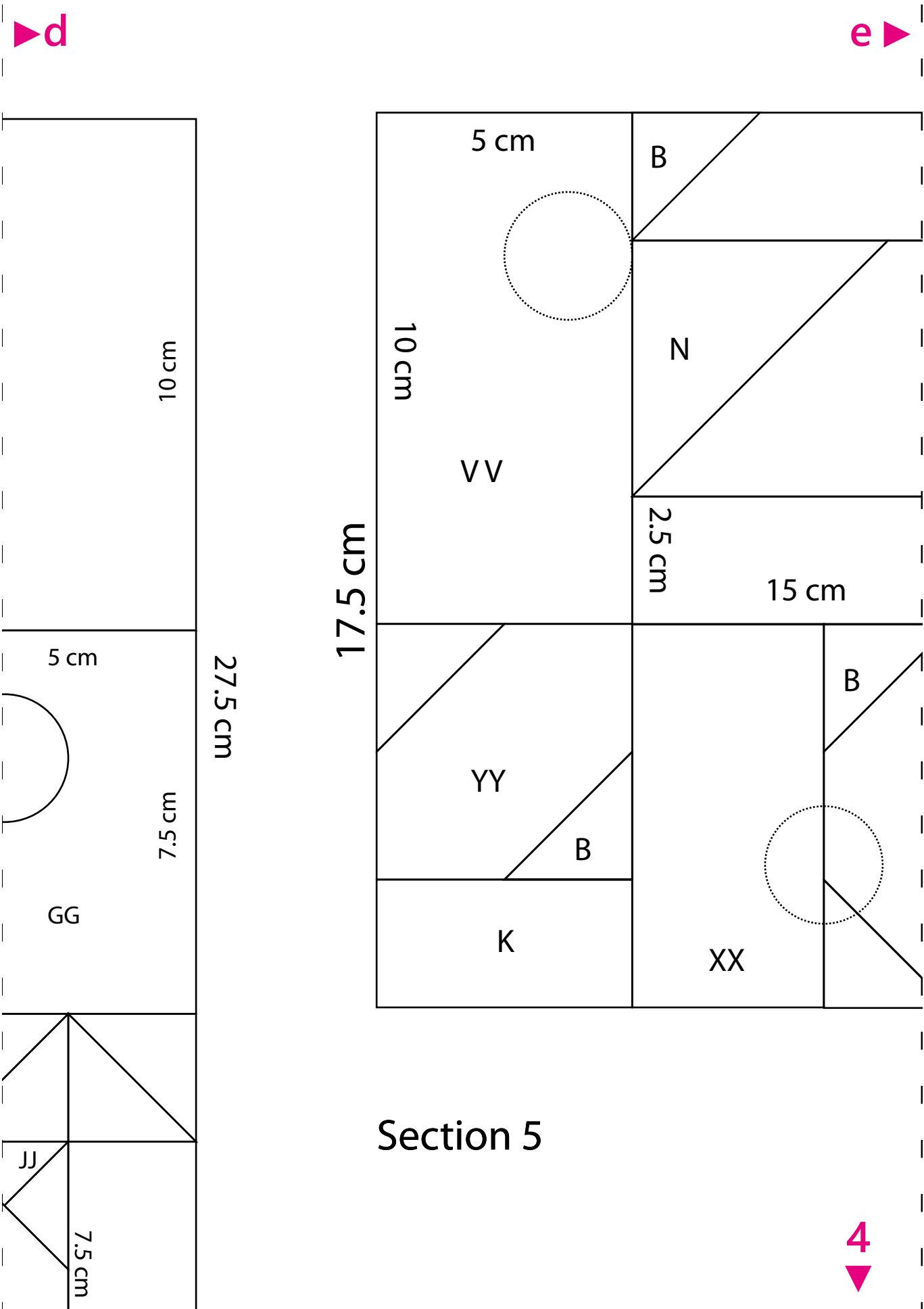

d

e

4

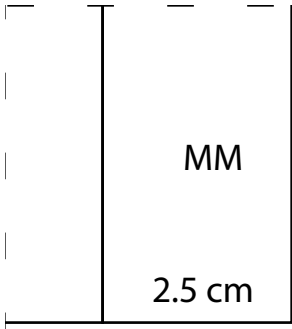

▼ 4

▶ o

p ▶

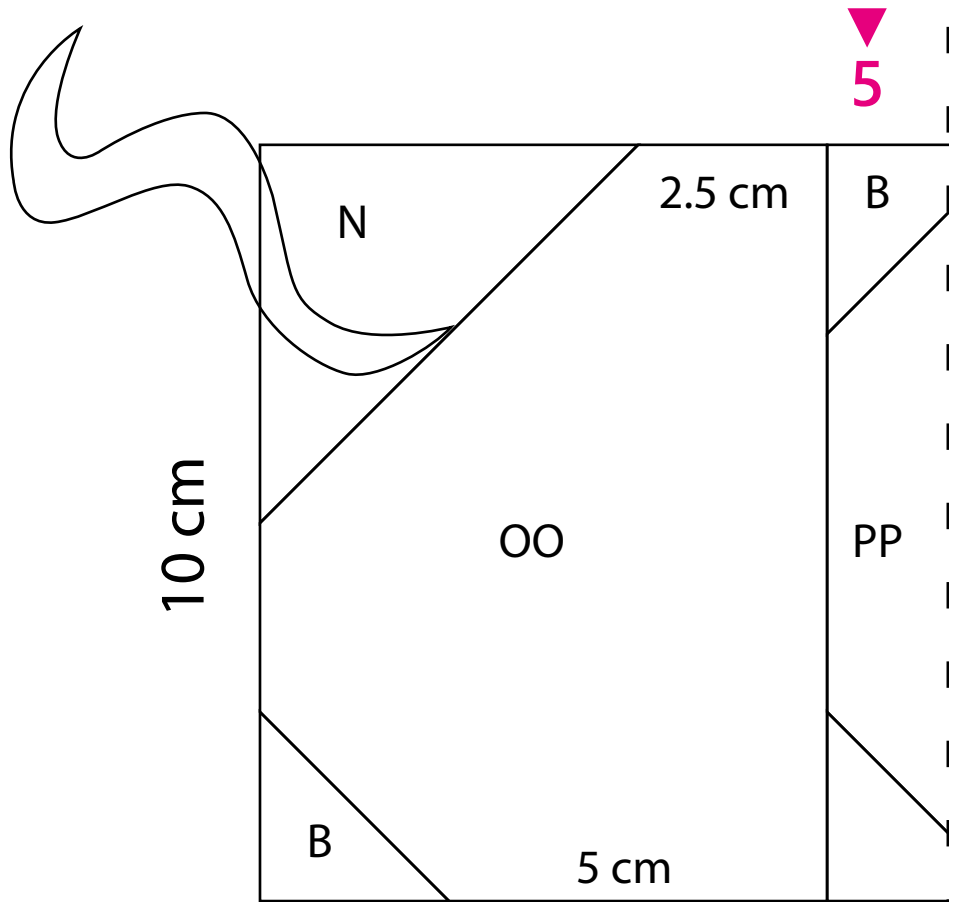

▼ 5

▶ p

q ▶

e

20 cm

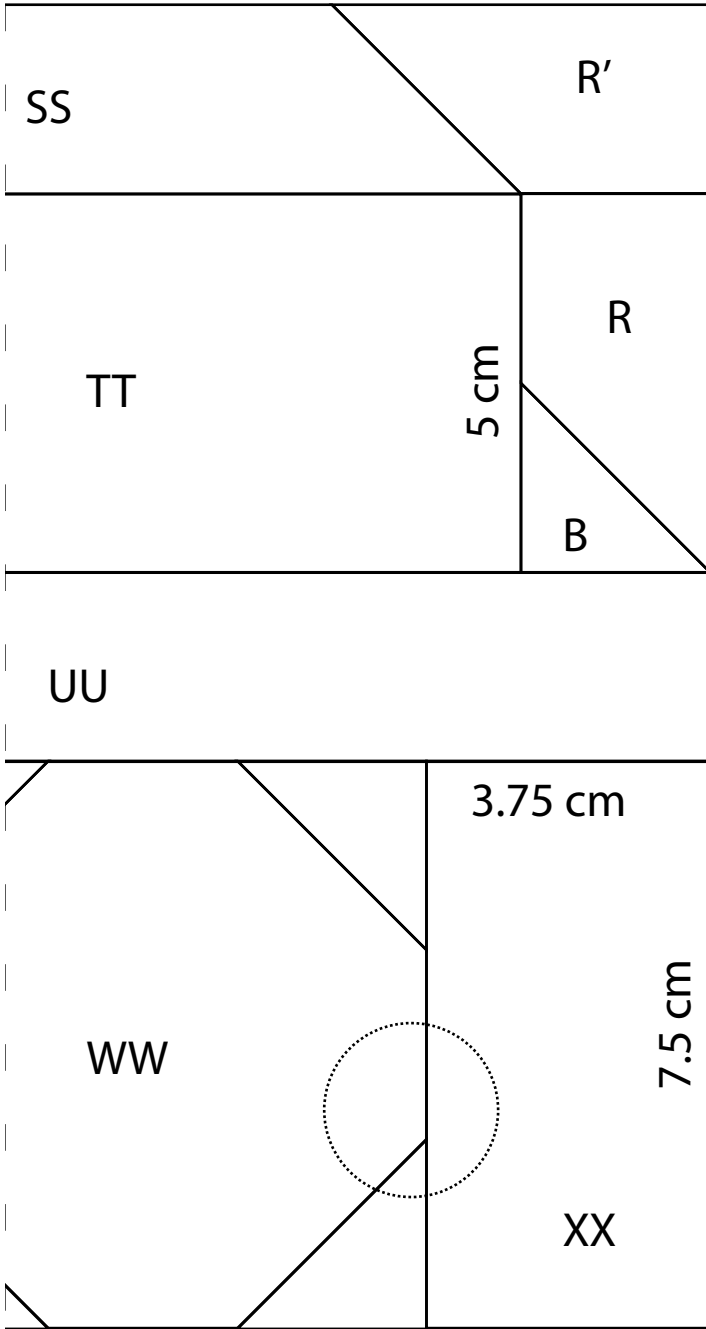

f

17.5 cm

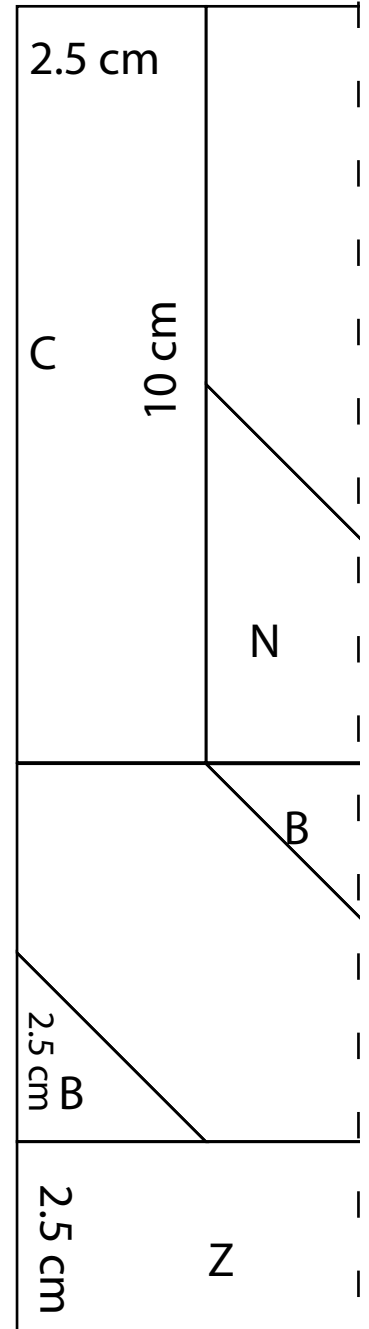

Section 6

5

f

g

50 cm

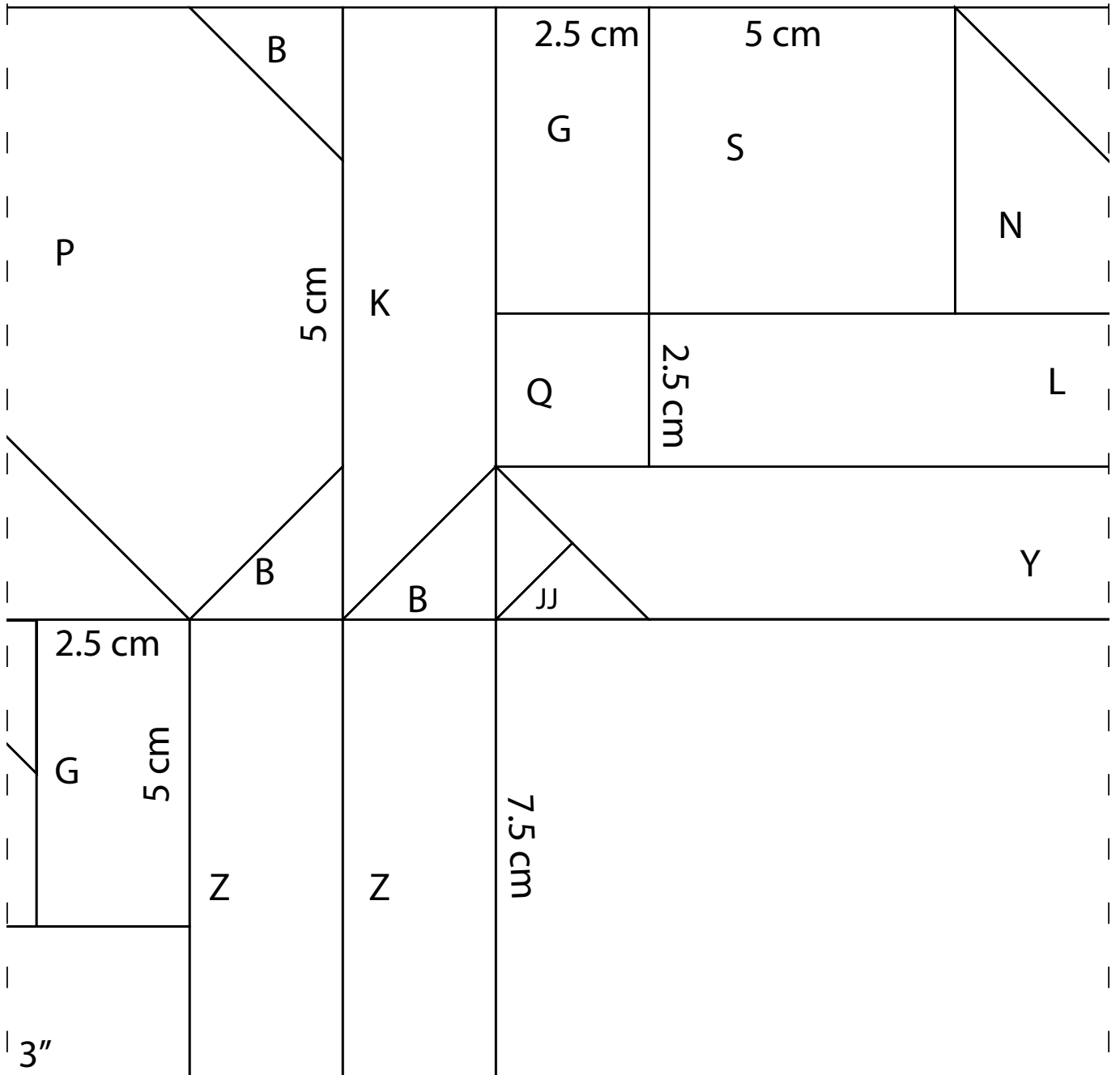

Toute reproduction, et notamment impression sur support papier ou duplication numérique, doit rester dans le strict cadre légal de la copie privée. La distribution, la revente, la copie, l'échange, ou toute diffusion gratuite ou payante des patrons numériques sont strictement INTERDITS, quel qu'en soit le support (électronique ou imprimé).

Any reproduction, particularly of digital or hard copies, must be in accordance with the legal framework for private copying. The transfer, resale, duplication, exchange or free distribution are strictly PROHIBITED, in any form whatsoever (digital or hard copy).

6

▶g

h▶

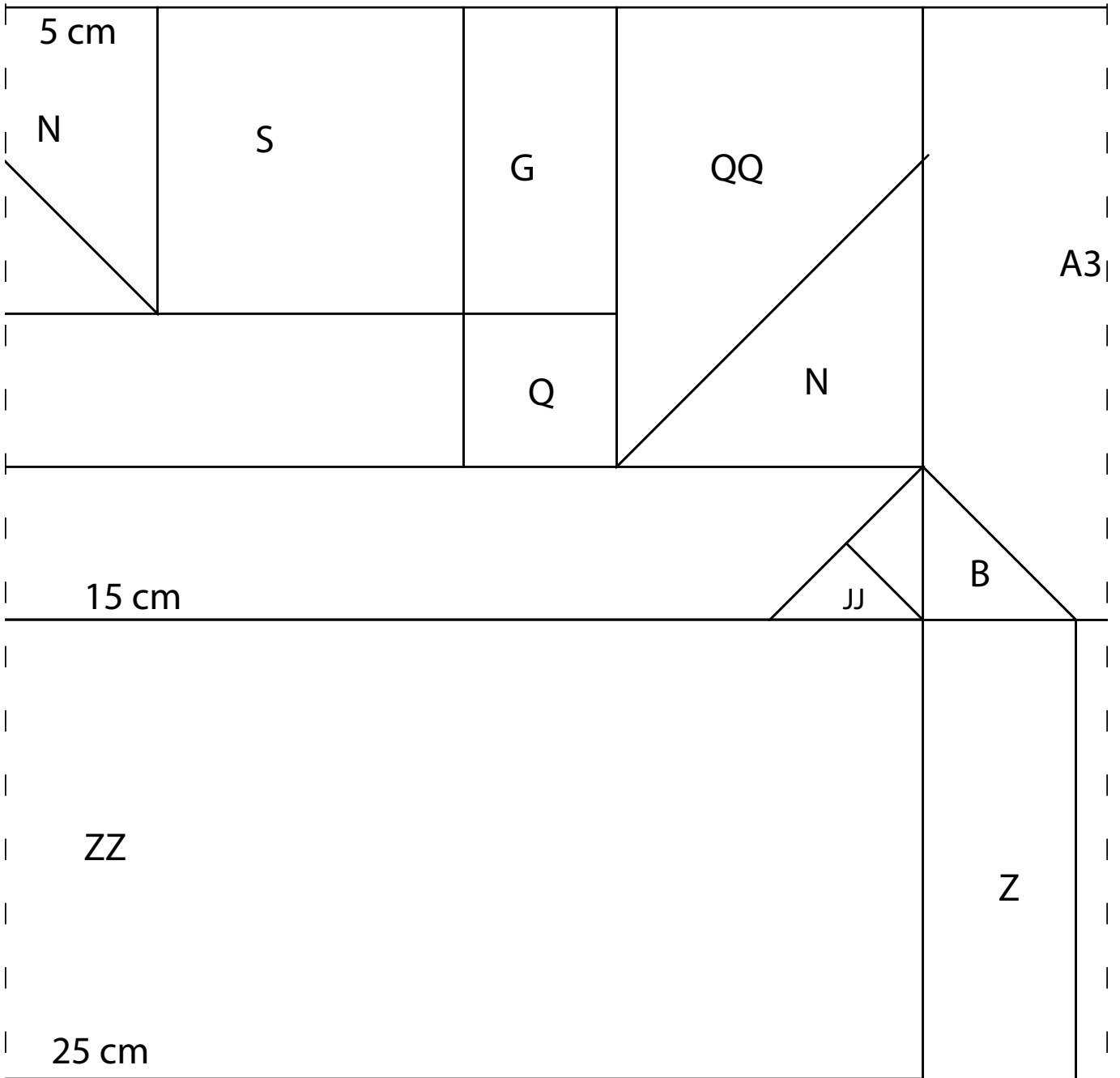

7▼

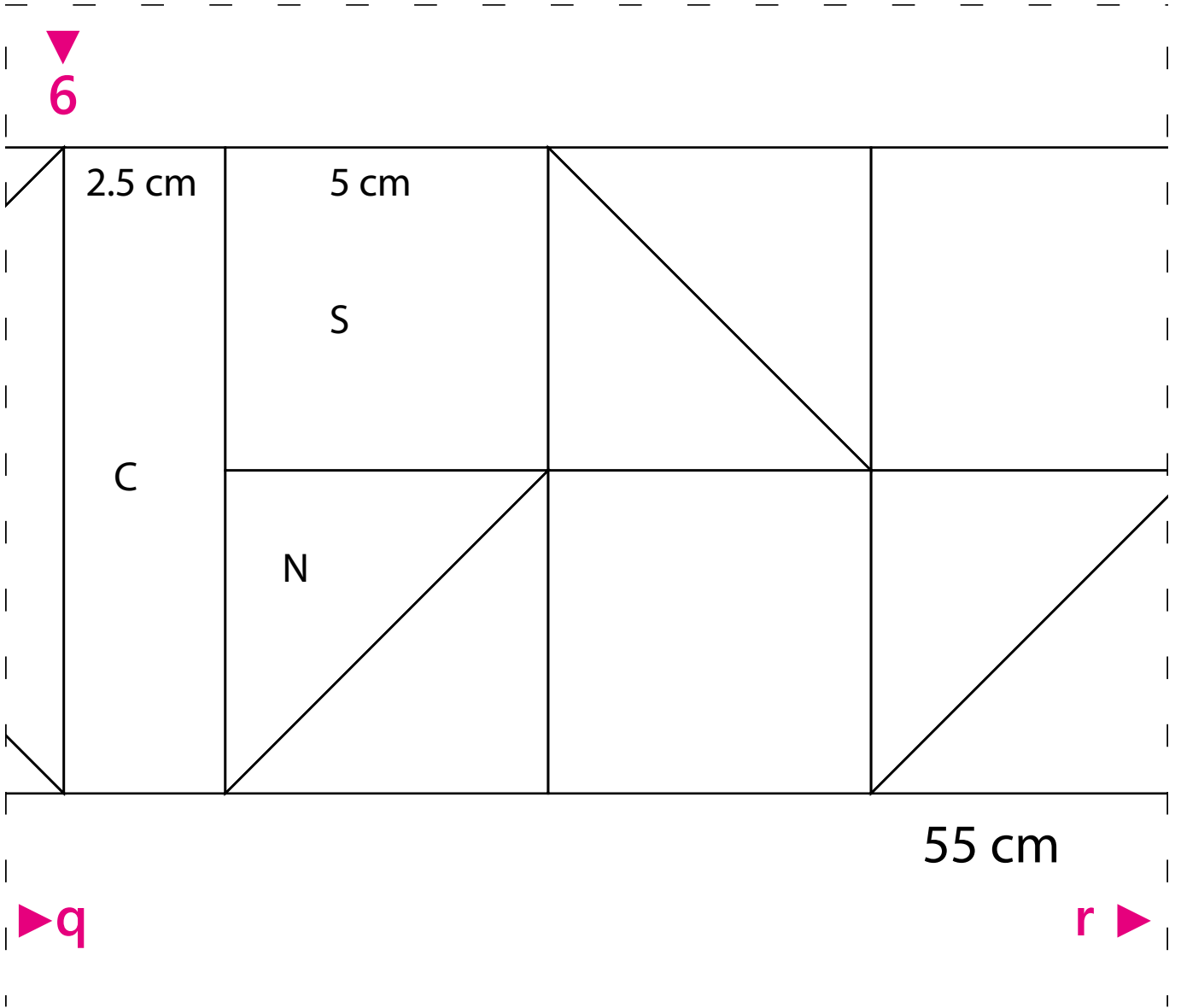

7

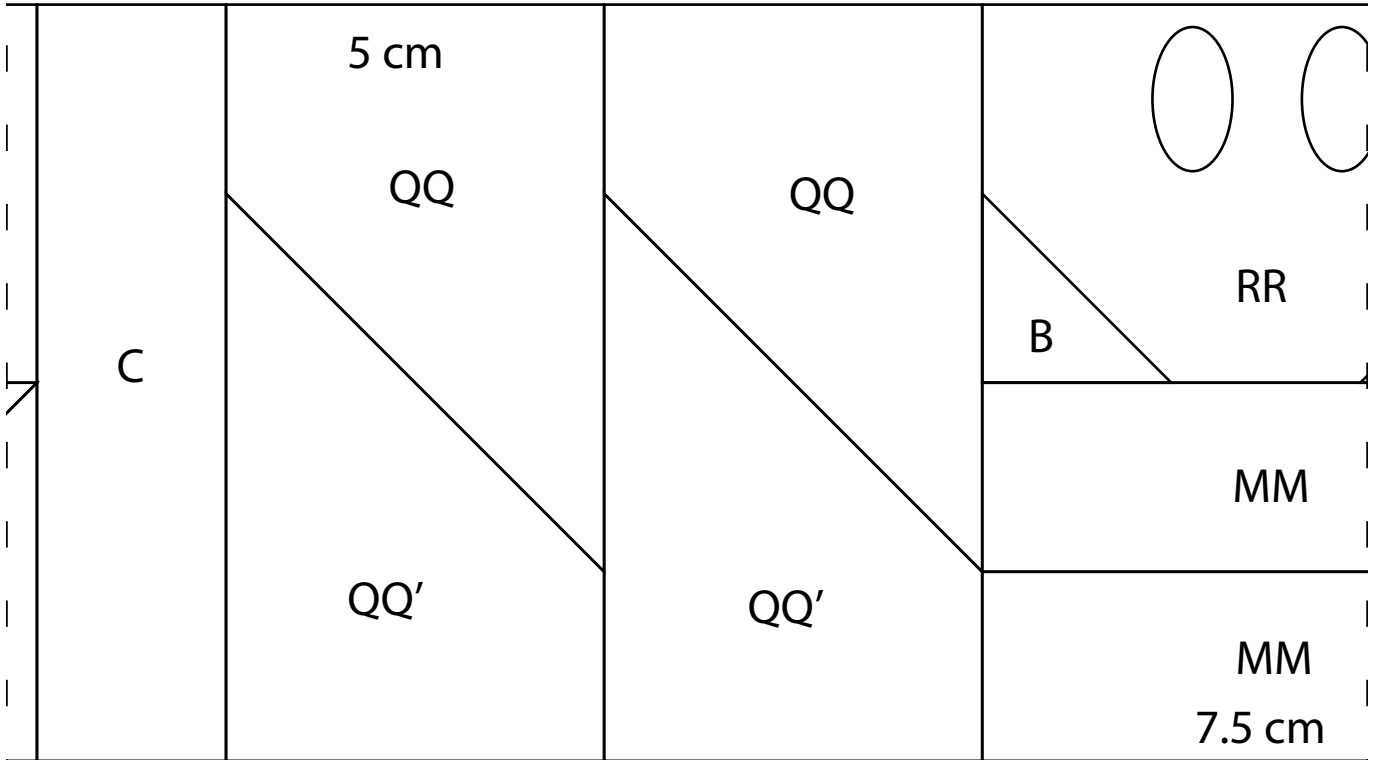

r

s

▶ h

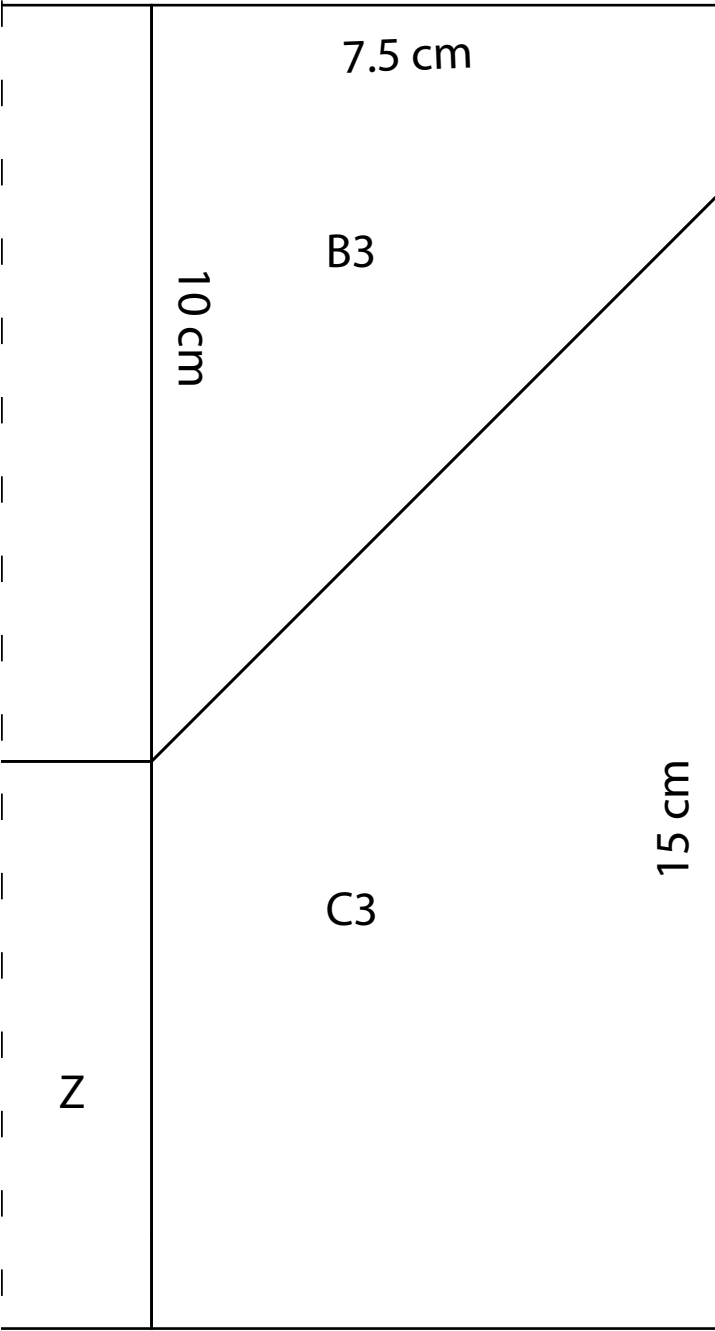

8 ▼

i ▶

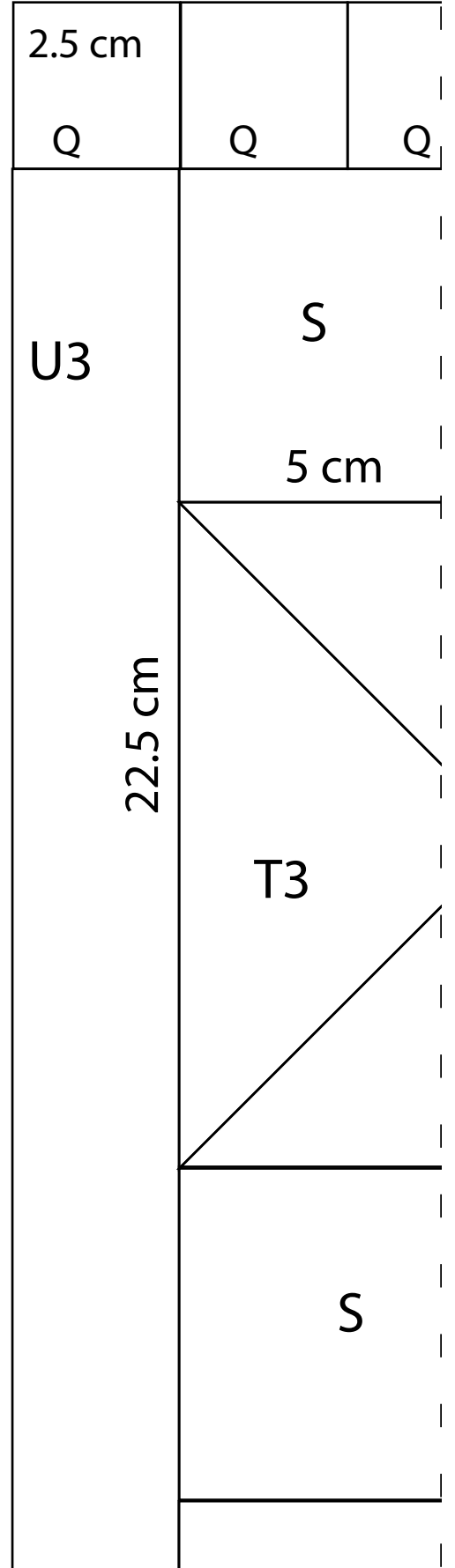

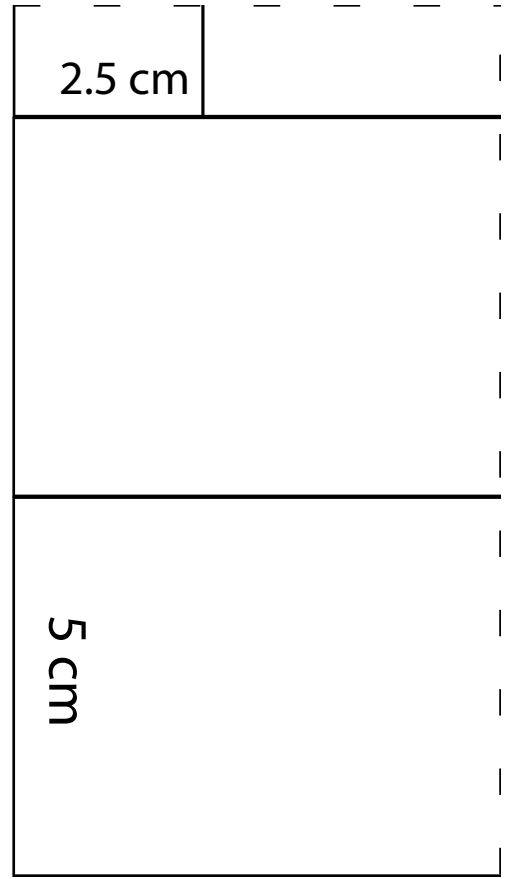
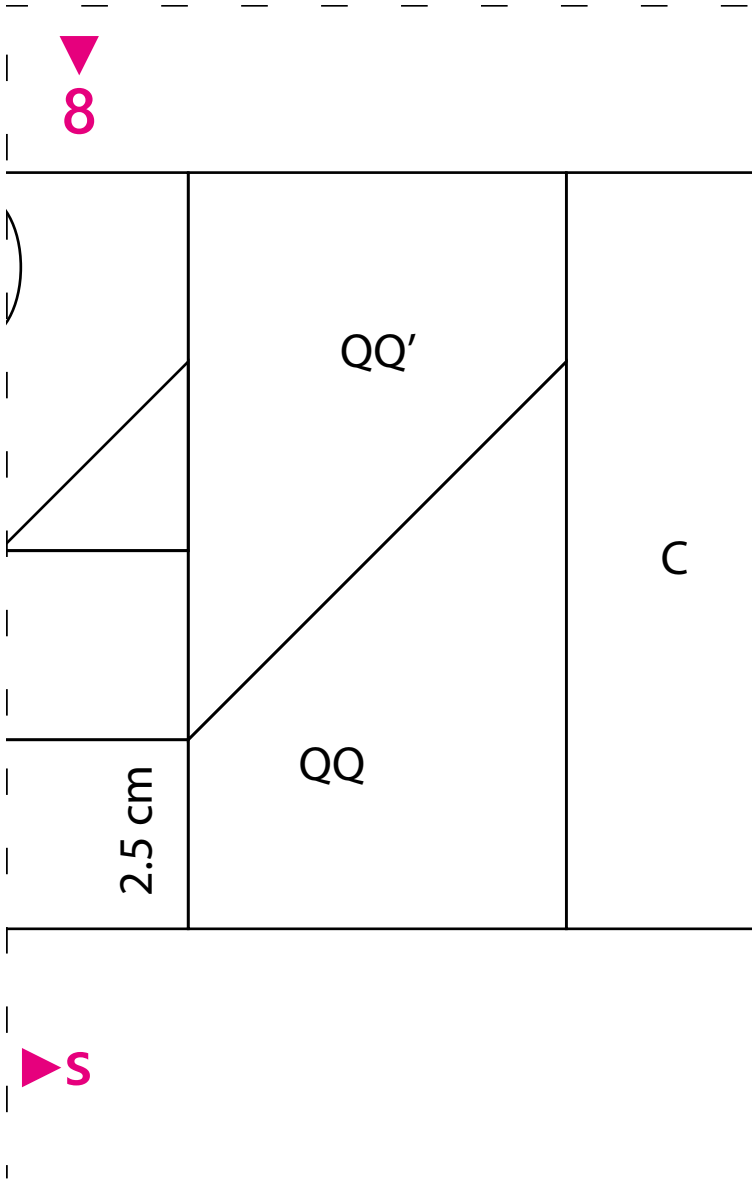

Section 8

t

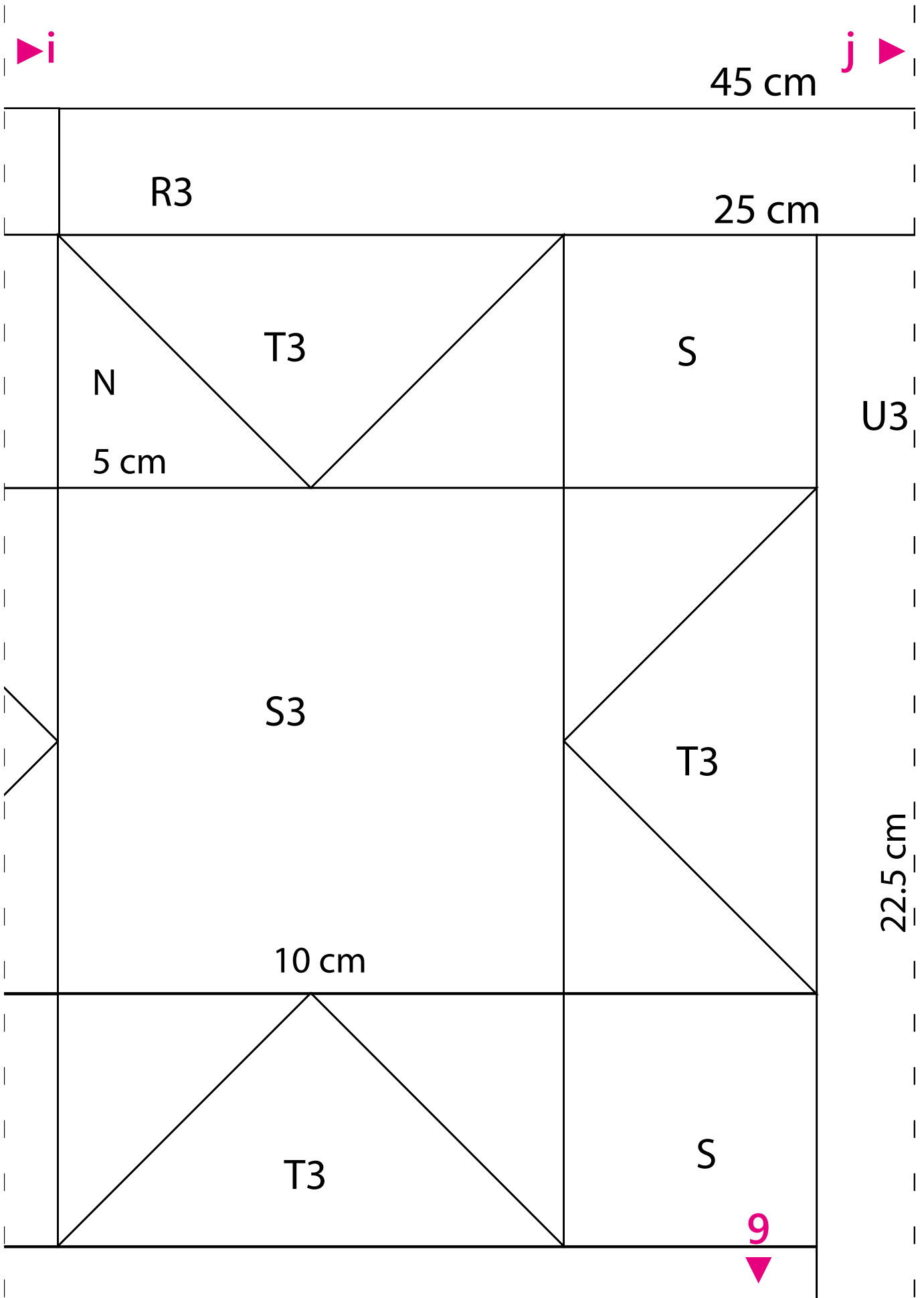

j ▶

k ▶

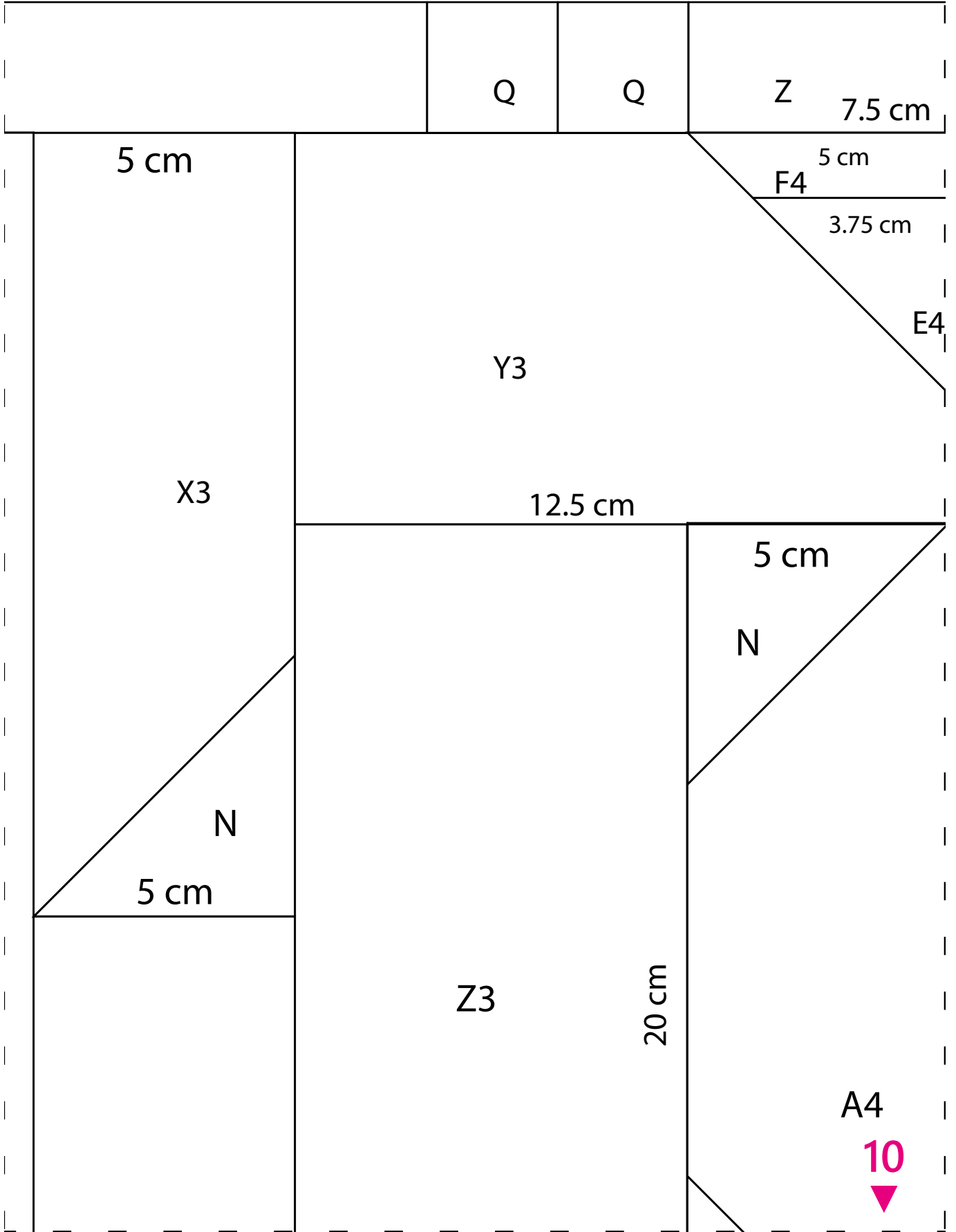

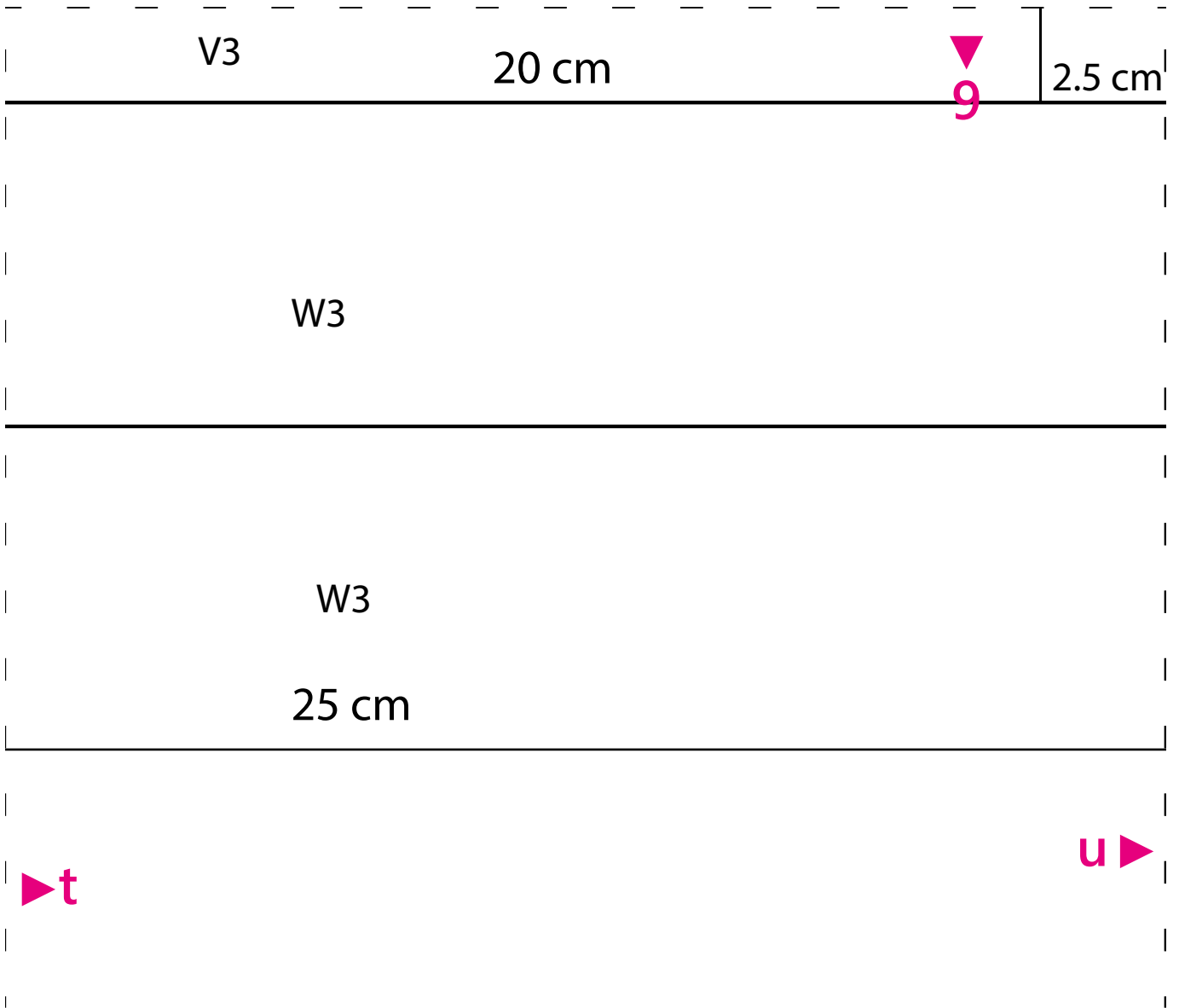

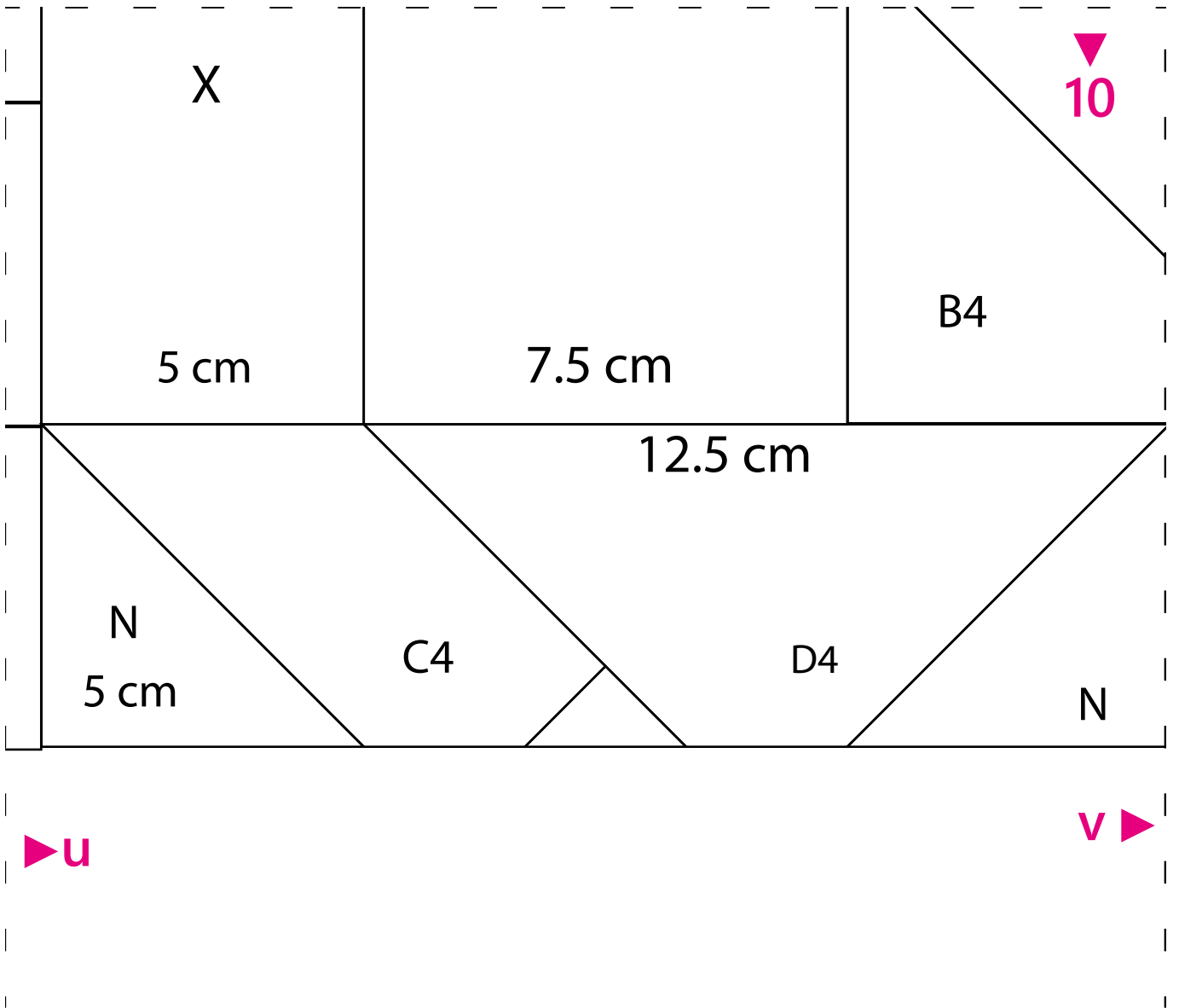



25 cm

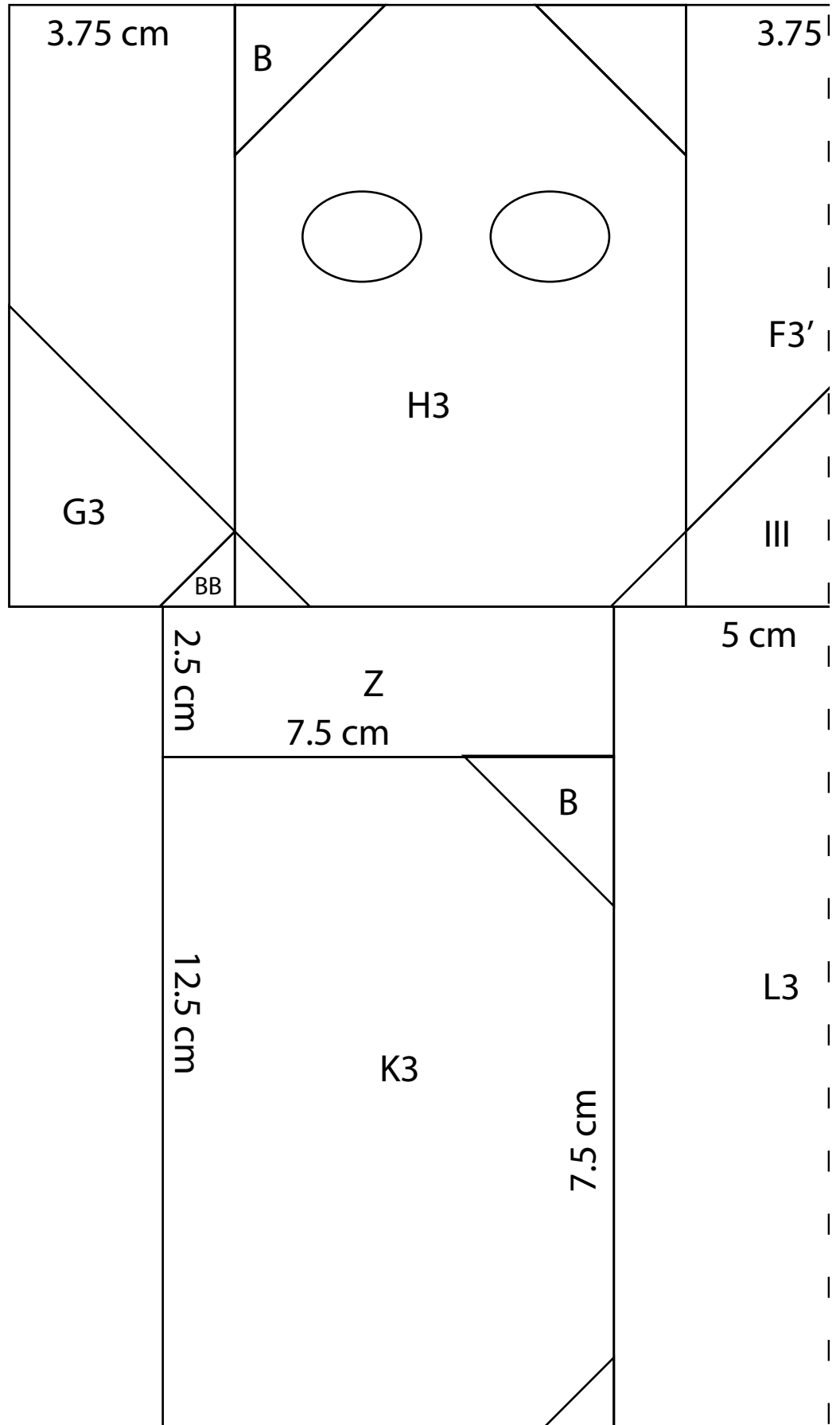
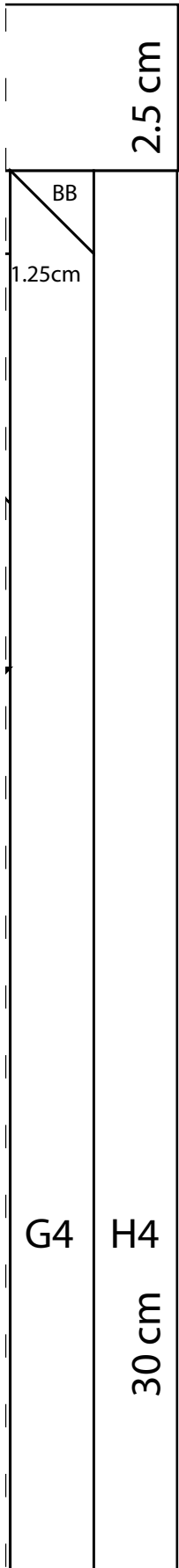

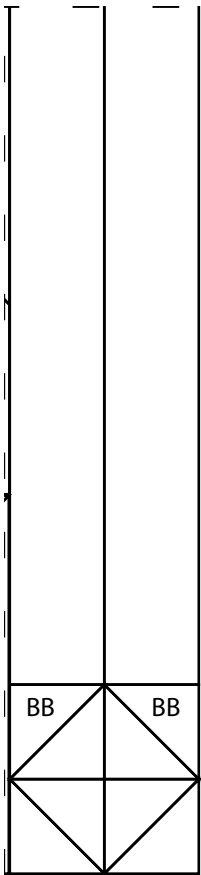

11

V

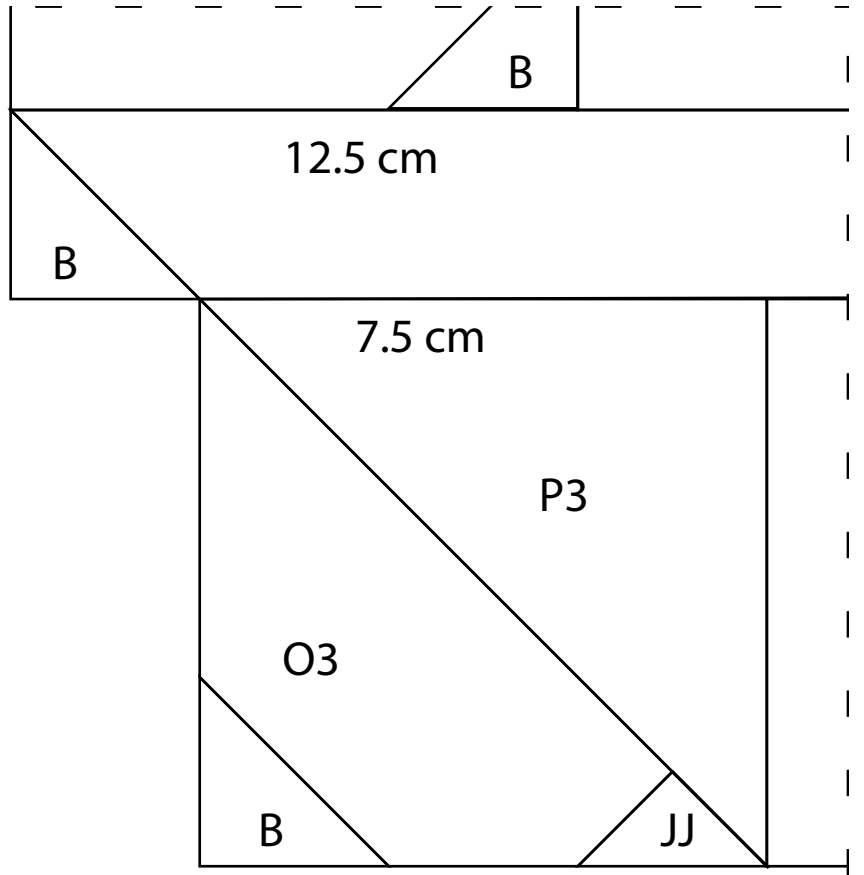

Section 7

W

